

B1&L1/L/S/ 北斗有源天线

Anray201580150FA01

电气性能:

- 频段&极化方式
 - B1: 1561.1 ± 2.046MHz (右旋)
 - L1: 1575.42 ± 1MHz (右旋)
 - L: 1615.68 ± 4.08MHz (左旋)
 - S: 2491.75 ± 4.08MHz (右旋)
- 驻波 < 1.5
- 增益 (带SET)
 - B1/L1 > 1.5dBi
 - L > 2dBi
 - S > 3dBi
- 阻抗 50 Ω (典型值)
- 收发成功率 > 95%
- 放大器 增益 15 ± 2dB
- 噪声系数 ≤ 2.0 FdB
- 驻波 < 2.0
- 供电电压 3.3V

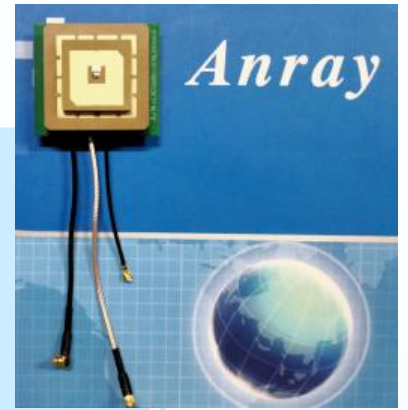

外形图 (单位: mm)

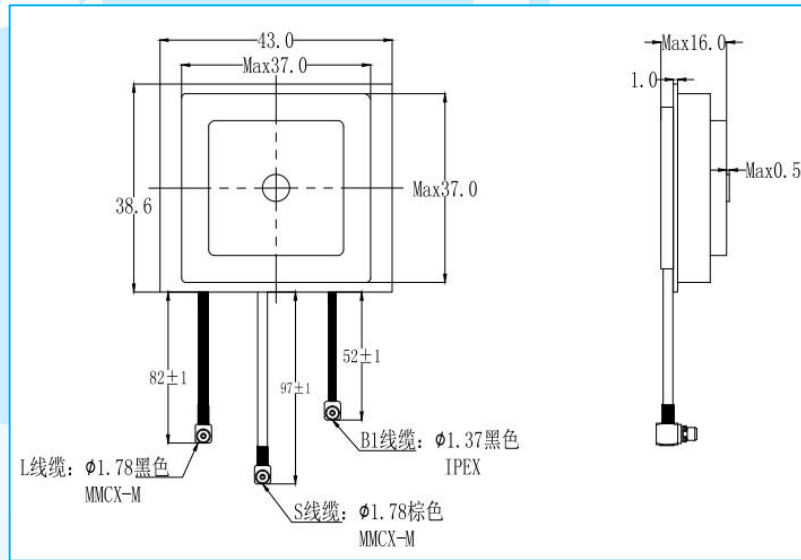

机械性能:

- 天线尺寸 43*38.6*16mm
- 同轴线缆
 - B1/L1: 黑色 φ1.37mm-IPEX
 - S: 棕色 φ1.78mm-MMCX
 - L: 黑色 φ1.78mm-MMCX
- 工作温度 -20~+70°C
- 环保 满足ROHS
- 应用范围 手持机/移动设备/其他

注意:

- 1、接头形式可根据客户要求进行制作;
- 2、测试环境: 开阔无明显遮挡的空旷地点。

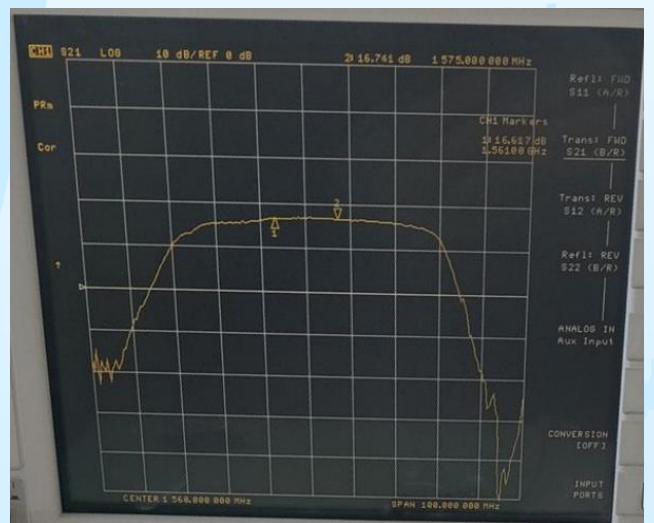

B1/L1有源增益 (加电3.3V)

- 电性能截图

VSWR:B1/L1频段

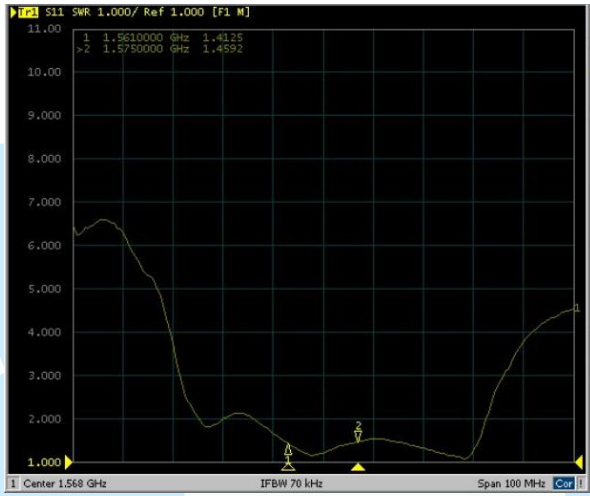

E-面@1561MHz

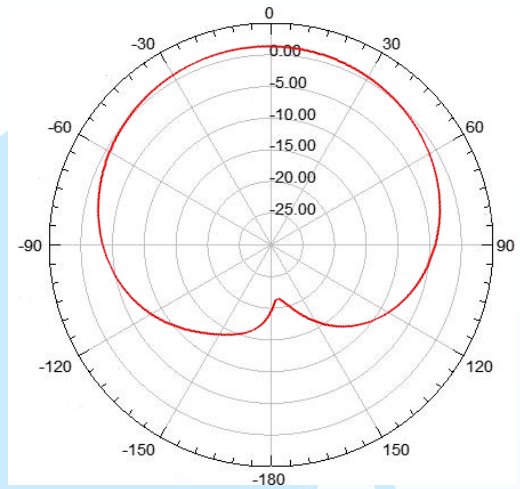

VSWS:L频段

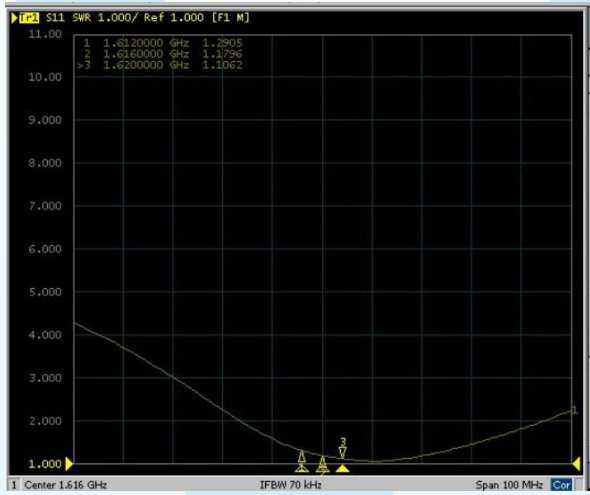

E-面@1616MHz

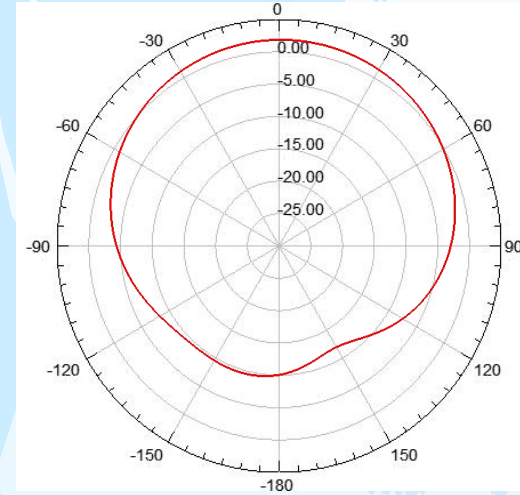

VSWS:S频段

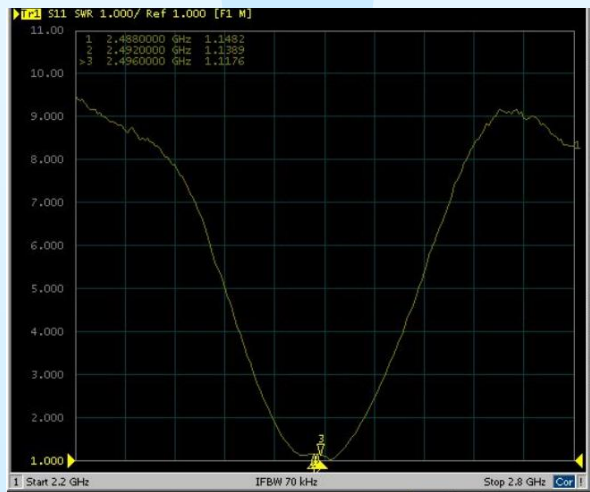

E-面@2492MHz

