

## 鸿雁卫星天线

### Anray210280360AA01

#### 电气性能:

- 频段
  - 接收: 1518~1525MHz
  - 发射: 1668~1675MHz
- 驻波
  - <1.8
- 最大增益
  - >2dBi
- 10° 仰角增益
  - >-3dBi
- 阻抗
  - 50Ω (典型值)
- 极化方式
  - 接收: 左旋圆极化
  - 发射: 右旋圆极化
- 最大承受功率
  - 5W



外形图: (单位: mm)

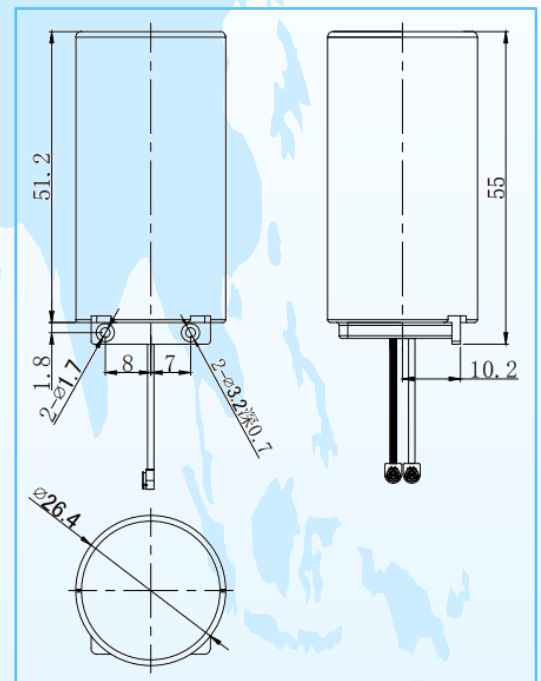

#### 机械性能:

- 尺寸
  - φ 26.4\*55mm
- 外壳材质
  - ABS/Other
- 同轴线缆
  - φ 1.13\*50mm
- 馈电方式
  - RF-I/Other\*2
- 工作温度
  - 20° ~ +70° C
- 环保
  - 满足RHOS
- 应用范围
  - 手持机/无人机等

备注: 接头方式和颜色可根据客户要求定制。

## 电性能截图

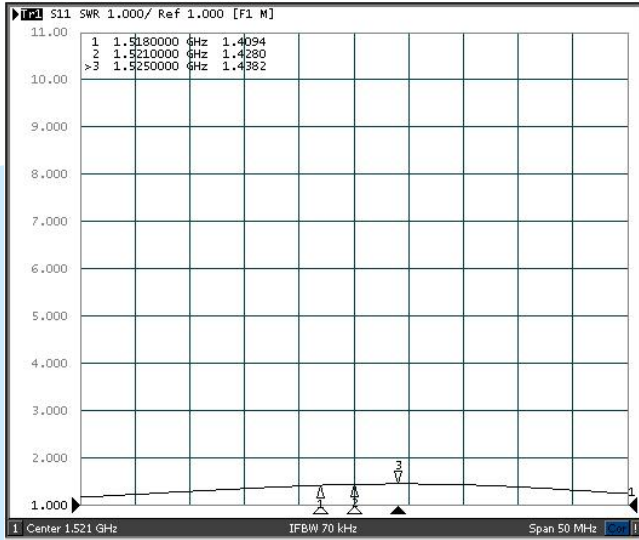

**VSWR (1518~1525MHz)**

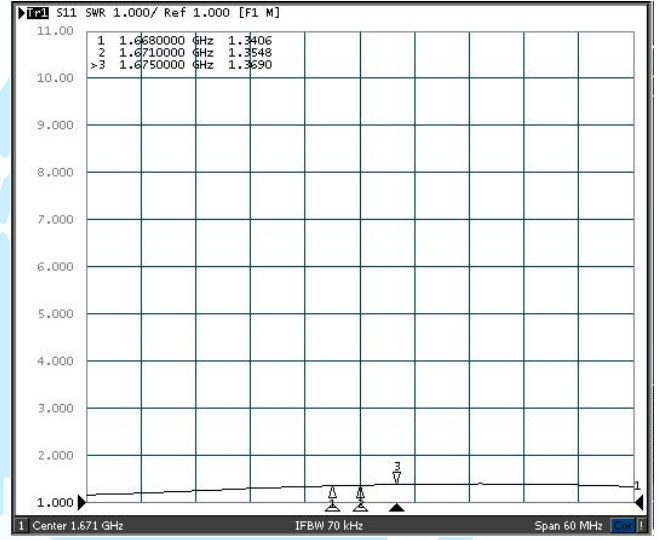

**VSWR (1668~1675MHz)**

1521MHz

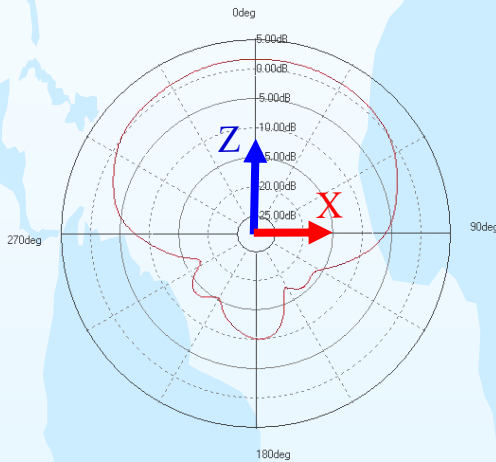

1671MHz

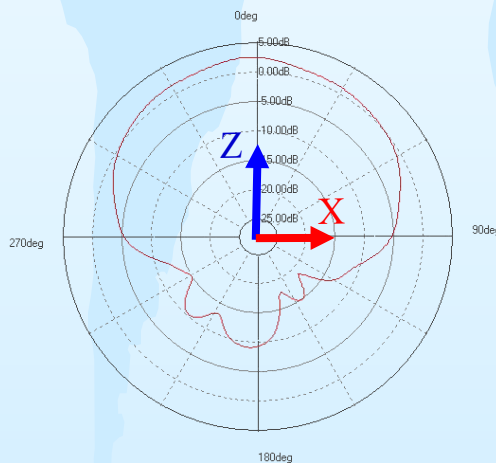

**ZX-面**

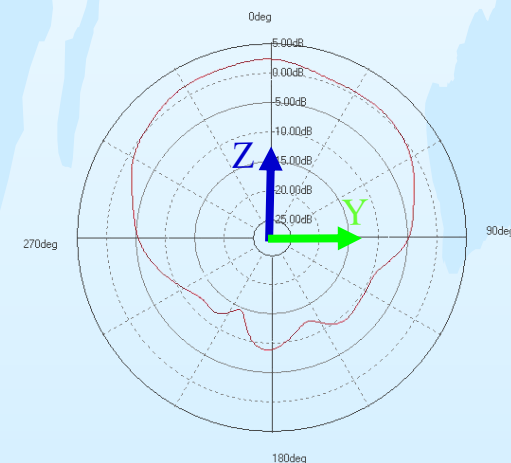
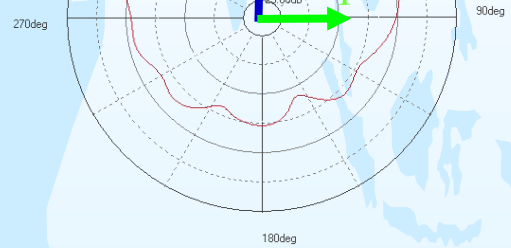

**ZY-面**